

Anti-Phospho-PDGF Receptor β (Y1009)

Background : Platelet-derived growth factors (PDGFs) have been implicated in the control of cell proliferation, survival and migration. The PDGF family of growth factors consists of five different disulphide-linked dimers built up of four different polypeptide chains encoded by four different genes. These isoforms, PDGF-AA, PDGF-AB, PDGF-BB, PDGF-CC and PDGF-DD, act via two receptor tyrosine kinases, PDGF receptors α and β . Thus far, gene-targeting experiments have been attempted to create knockout mice deficient for PDGFR- α or PDGFR- β . Those mice, however, died either at the embryonic stage or several days after birth. Platelet-derived growth factor receptors, PDGFR- α and PDGFR- β , have five extracellular immunoglobulin-like domains and an intracellular tyrosine kinase domain. Upon binding a PDGF, the receptors form homo- and heterodimers. Dimerization of the receptors juxtaposes the intracellular part of the receptors, which allow phosphorylation in trans between the two receptors in the complex. These autophosphorylation provide docking sites for downstream signal transduction molecules. More than 10 different SH₂-domain-containing molecules have been shown to bind to different autophosphorylation sites in the PDGF α - and β -receptors. There are signal transduction molecules with enzymatic activity, such as PI3-kinase, PLC- γ , Src, SHP-2, GAP, as well as adaptor molecules such as Grb2, Shc, Nck, Grb7 and Crk, and Stats. Each of the different partners recruited by the activated receptor initiates different signaling pathways, making possible a great variety of cellular response.

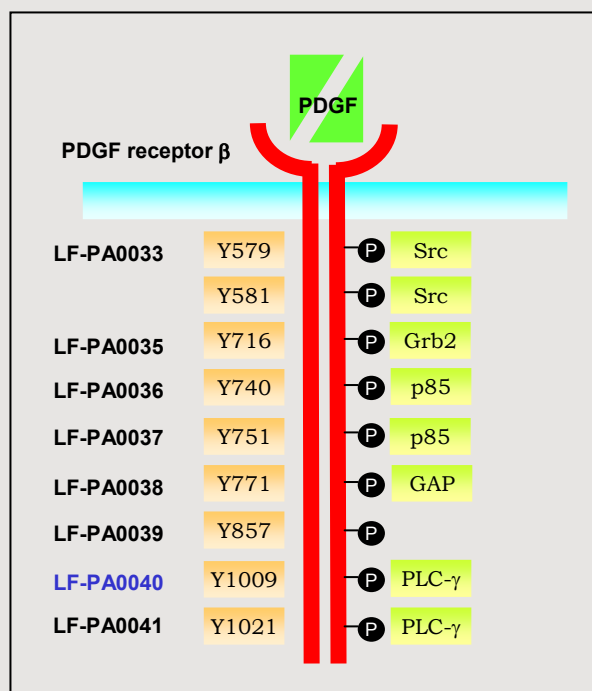

Immunogen : Synthetic phosphorylated peptide (KLH coupled) corresponding to residues surrounding Tyr 1009 of human PDGF Receptor β

Host : Rabbit

Size : 100 μ l

Composition : PBS containing 50% glycerol

Positive control : NIH/3T3 cell lysates stimulated with PDGF-BB

Storage : Store for 1 year at -20°C from date of shipment

Species cross reactivity

Human	Mouse	Rat
+	+	NT

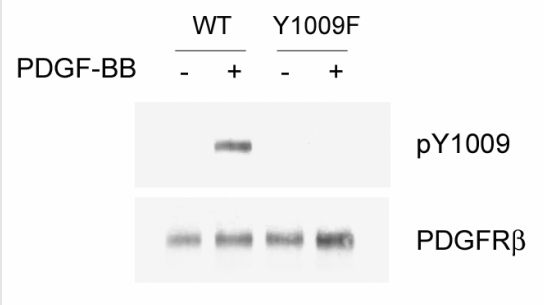

IMMUNOBLOT ANALYSIS of cell lysate:

HepG2 cells were transfected with wild-type or Y1009F mutants of PDGF Receptor β . Transfected HepG2 cells were either untreated (-) or treated with PDGF-BB (+). Immunoblotting was done with anti-phospho-PDGF Receptor β (Y1009) (upper) or anti-PDGF Receptor β (lower).

Applications :

Western Blotting (1:2000)

Background Reference:

- 1) Heldin, CH. et al. (1998) *Biochim. Biophys. Acta*, 1378(1), F79-F113
- 2) Claesson-Welsh, L. (1994) *J. Biol. Chem.* 269(51), 32023-32026
- 3) Soriano, P. (1997) *Development*, 124, 2691-2700
- 4) Soriano, P. (1994) *Genes Dev.* 8, 1888-1896

Related Products :

Anti-PDGF Receptor- β (Y579) [#LF-PA0033]

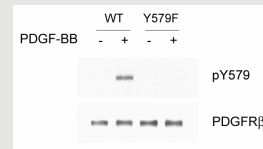

Anti-PDGF Receptor- β (Y716) [#LF-PA0035]

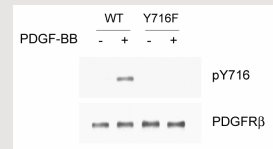

Anti-PDGF Receptor- β (Y740) [#LF-PA0036]

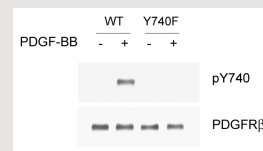

Anti-PDGF Receptor- β (Y751) [#LF-PA0037]

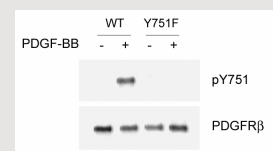

Anti-PDGF Receptor- β (Y771) [#LF-PA0038]



Anti-PDGF Receptor- β (Y857) [#LF-PA0039]

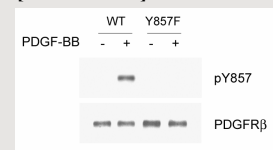

Anti-PDGF Receptor- β (Y1009) [#LF-PA0040]

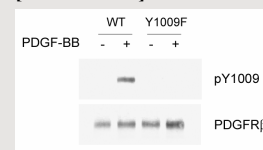

Anti-PDGF Receptor- β (Y1021) [#LF-PA0041]

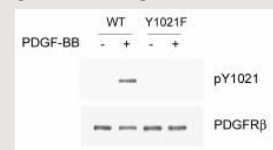

FOR RESEARCH PURPOSE ONLY
NOT FOR DIAGNOSTIC OR THERAPEUTIC USE